



# Application

## General Procedures for Interior and Exterior Dry Application

For the most current 3M Technical Information available to successfully use this product, please view this Bulletin electronically and click on the blue underlined links to view the relevant documents.

### 1. Table of Contents

2. How to Use This Bulletin Effectively	1
3. Health and Safety	2
4. Film Overview	2
5. Tools	3
6. Temperature and Environment	3
7. Substrate Preparation	4
8. Pre-application Information	4
A. General	4
B. When to Use Wet Application Methods	4
C. When to Use Dry Application Methods	5
E. Graphic Placement	5
F. Making Film Overlaps - Exterior Only	5
G. Registering the Graphic	5
H. Removing the Adhesive's Liner	6
I. Using Heat During Application	6
9. Application Sequences	6
A. Applying a Small Graphic	6
B. Applying a Large Graphic	7
C. Applying Large, Prespaced Graphics	9
D. Applying Striping	10
E. Alternate Squeegee Technique	11
10. Finishing	11
A. Removing the Application Tape	11
B. Re-squeegeeing	12
C. Removing Air Bubbles	12
D. Air Release and Cutting Around Bolts and Rivets	12
E. Slitting Substrate at Seams	15
11. Edge Sealing	16
12. Irregular Surfaces and Shapes	17
13. Warranty and Limited Remedy	17
14. Bulletin Change Summary	17

### 2. How to Use This Bulletin Effectively

This bulletin gives you general techniques for the dry application of films and sheetings with pressure-sensitive or pressure-activated adhesive to a relatively flat surface.

For the best results:

- For complex curves and contours, pump graphics, special applications and vehicles, see [3M Instruction Bulletin 5.4, Special Applications and Vehicles](#), and [3M Instruction Bulletin 5.36, Special Considerations for Automobiles, Vans and Buses](#).
- For wall surface applications, see [3M Instruction Bulletin 5.37, A Guide to Understanding and Applying Graphics to Common Interior Wall Surfaces](#).
- To prepare the substrate prior to graphic application, see [3M Instruction Bulletin 5.1, Application, Substrate Selection, Preparation and Substrate-specific Application Techniques](#).
- Applying a graphic is more than just adhering the film to the substrate. Be sure you read and follow the instructions in all bulletins referenced in the sections you are using.

### 3. Health and Safety



**CAUTION**

When handling any chemical products, read the manufacturers' container labels and the Safety Data Sheets (SDS) for important health, safety and environmental information. To obtain SDS sheets for 3M products go to [3M.com/MSDS](http://3M.com/MSDS), or by mail or in case of an emergency, call 1-800-364-3577 or 1-651-737-6501.

When using any equipment, always follow the manufacturers' instructions for safe operation.

#### Air Quality Regulations

State Volatile Organic Compound (VOC) regulations may prohibit the use of certain cleaning chemicals with VOC's in graphic arts coatings and printing operations. For example, the California South Coast Air Quality Management District prohibits use of certain solvent-based solutions without a permit and other California AQMD's prohibit use of certain solutions without a permit or a regulatory exemption. Check with your State environmental authorities to determine whether use of this solution may be restricted or prohibited.



**CAUTION**

Before using any equipment, always read the manufacturer's instructions for safe operation.

Any activity performed for a long period of time in an awkward position or with a high amount of force is potentially a risk for causing musculoskeletal strain, pain or injury. When applying graphics, follow these practices to improve comfort and avoid injury:

- Alternate your tasks during the application.
- Schedule regular breaks.
- Perform stretches or do exercises to improve circulation.
- Avoid awkward reaching.

### 4. Film Overview

Understanding the unique characteristics of the film and its adhesive will help you use the film properly. Refer to the base film's Product Bulletin and the following comparison of adhesive features.

#### (1) 3M™ Controltac™ Graphic Films

- Pressure-activated adhesive allows you to slide the film across an approved substrate to position it.
- Apply light finger pressure to temporarily tack film to check for proper positioning. Lift and slide to reposition.
- If graphic film sticks prematurely and no firm pressure has been applied, the film can be lifted and repositioned.
- The film immediately loses all of its slideability and repositionability if firm pressure is applied with hand, squeegee or other application tool; which bonds the adhesive to the substrate.
- The film loses much of its slideability and positionability if it is applied to a substrate in excess of 100°F (38°C) or if any part of the film is removed from the original liner and reapplied to the same or another liner.
- Attempting to lift applied film typically stretches it beyond reuse. Some skilled installers may be able to successfully lift small sections to work out air bubbles, but 3M does not guarantee success.
- Refer to the film's Product Bulletin to determine if the one you are using is removable.

#### (2) 3M™ Scotchcal™ Graphic Films

**Most 3M™ Scotchlite™ Reflective Graphic Films and Sheetings**

**3M™ Graphic Films**

- Pressure-sensitive adhesive adheres to the substrate upon contact even with only light finger pressure.
- Film is not repositionable. Lifting the film typically causes it to stretch beyond use. Some skilled installers may be able to successfully lift small sections to work out air bubbles, but 3M does not guarantee success.
- Refer to the film's Product Bulletin to determine if the one you are using is removable.

**(3) Any 3M Graphic Film with Comply™, Comply™ v2 or Comply™ v3 Adhesive**

These features apply to any 3M graphic film on which the 3M Comply adhesive technology is used.

- A unique microstructured pattern in the adhesive allows trapped air to exit laterally through special air release channels for faster and easier installations with few or no bubbles.
- Any bubbles that do occur can usually be rubbed out.
- The air release channels in versions 2 and 3 of this adhesive have improved air flow.
- The air release channels make application easier even for less skill installers.
- Always work from the center out to the edges of the film. If the channels are closed off by firm pressure and air is trapped, use an air release tool to aid in removing air bubbles. Removing the liner and attempting to reapply it or another liner damages the air release channels. See more application details later in this bulletin.
- Some of these films also are removable. Refer to the film's Product Bulletin to determine if the film you are using is removable.

**(4) 3M™ Scotchlite™ Reflective Graphic Film 680 and IJ680 versions**

- Pressure-activated adhesive allows you to slide the film across an approved substrate to position it.
- Avoid applying even light finger pressure while sliding the film into position. Any pressure damages the reflective properties of the film.
- This film is not repositionable.
- This film is not removable.

## 5. Tools

- Scotch™ Masking Tape, 1 inch (25.4 mm) or wider
- 3M™ Plastic Applicator PA-1 (Blue or Gold\*)
  - The gold applicator is most commonly used. It is stiffer than the blue applicator, which allows maximum application pressure.
  - The blue applicator is used when you need more flexibility. It is softer, which allows you to mold it around contours and corrugations.
- 3M™ Low Friction Sleeve SA-1\*
- 3M™ Rivet Brush RBA-1\*
- 3M™ Power Grip Rivet Brush Applicator RBA-3\*
- Pin or 3M™ Air Release Tool 391X\*
- 3M™ Power Grip Multi-Pin Rivet Air Release Tool MPP-1
- 3M™ Power Grip Applicator CPA-1 (flat surface only) *for films with Comply adhesive*
- 3M™ Power Grip Magic Pad Rivet Applicator CMP-1 *for films with Comply adhesive*
- 3M™ Edge Sealer\* (Use the one recommended in the base film's Product Bulletin)
- Hand-held rivet cutting tools such as 3M™ Film Cutting Tool FT-13/32 or FT-1/2; replacement tips available.\*
- Cutting tools, such as a razor blade with a safety holder
- Industrial heat gun; must be capable of attaining 500° to 750°F (260° to 399°C), or equivalent
- 1/4 inch (0.6 mm) paint brush for applying edge sealer

\*Available from 3M Commercial Solutions

## 6. Temperature and Environment

Apply graphics when the air, film and substrate temperatures are within the range specified in each film or sheeting's Product Bulletin. An incorrect temperature can prevent the film or graphic from performing as expected.

## A. Conditions that Affect Graphic Application

- Graphics applied above the maximum recommended application temperature may pre-adhere.
- Above the maximum recommended application temperature, graphics constructed of Controltac brand films may lose their positionability feature.
- The temperature of the substrate must be above the dew point to prevent moisture from condensing on the surface.
- In very humid conditions, it may be difficult to keep the substrate dry.
- Below the minimum recommended application temperatures, films and sheetings become stiff and brittle. The adhesive cannot bond adequately with the substrate. In addition, air may be trapped and causing bubbling.
- Substrates may be heated in order to raise the surface temperature above the minimum specified. Use an appropriate portable heater or heat lamps.

## 7. Substrate Preparation

See [3M Instruction Bulletin 5.1](#) for details on cleaning specific substrates and special, required application techniques.

- If the substrate has dirt or loose paint on it, this is what the film adheres to—not the substrate itself. If the film does not make enough contact with a clean dry substrate, it will not stick well, leading to premature graphic failure.
- The final cleaning of the substrate must be done immediately before applying film. Dust and other contaminants can collect quickly on the substrate and prevent the film from adhering properly.
- Be sure the substrate, rivets and seams are thoroughly dry. Film adheres poorly even to a properly cleaned substrate if there is any remaining liquid around the rivets and seams.

## 8. Pre-application Information

### A. General

- Replace the plastic applicator if the edges become nicked or ragged. Damaged edges leave bubbles and scratch the graphic.
- If the graphic does not have an application tape, use a low friction sleeve on the applicator to minimize scratching the graphic.
- A smooth substrate is the most ideal application surface. However, many surfaces that appear smooth may actually be irregular or uneven, such as a speckled or textured plaster surface. These surfaces are generally used for interior walls but may be found elsewhere. Additional information on walls is included in [3M Instruction Bulletin 5.37, A Guide to Understanding and Applying Graphics to Common Smooth and Textured Wall Surfaces](#).

### B. When to Use Wet Application Methods

Only use an application liquid such as detergent and water if that method is *specifically recommended* in the film's Product Bulletin.

### C. When to Use Dry Application Methods

Any liquid remaining under the graphic prevents it from adhering properly. Certain substrates are very difficult to dry. We typically recommend only dry application for the following situations:

- Graphics made with Controltac and Scotchlite brand films.
- Graphics made with film having Comply brand adhesive.
- Scotchcal brand films unless its Product Bulletin specifically recommends wet application.
- Perforated window graphic film with an overlamine.
- Vehicles.
- Uneven, textured or non-flat application surfaces.
- Graphics subjected to freezing conditions within several days of application.

## D. Graphic Placement

Proper placement of the graphic can make the job easier. To minimize application problems, follow these guidelines for positioning the graphic.

Note: Do not lay the graphic on the floor. It will pick up dirt on the back and transfer it to your clean substrate.

- Test your layout by temporarily positioning the graphic on the substrate. Use masking tape to hold it in place. This ensures that the graphic will fit and all the pieces are available.
- Position the graphic to minimize the number of rivets and substrate seams that will be covered. Moving the graphic just 1 to 2 inches (2.5 to 5 cm) may avoid a row of rivets.
- If there are rivets, position the graphic so the film extends at least 1/2 inch (1.3 cm) past the rivet and covers as many rivets as possible. This eliminates the need to cut around the rivets.
- Do not allow the edge of a graphic to fall on rivets.
- If the film covers seams in the substrate, you will need to cut through the film as described in Substrate Seams on page 15.
- Grasping the edge of the film may transfer body oils and dirt to the adhesive. To minimize any problems with adhesion at those points, grasp the film as far into graphic as possible without wrinkling the film.

## E. Making Film Overlaps - Interior and Exterior

### Exterior

Environmental conditions such as wind, rain, and blowing debris stress the overlapped edges of graphics. Use careful planning for both vertical and horizontal film overlaps to reduce the stress and damage.

Note: Overlaps greater than 1 inch (25.4 mm) can result in lifting and graphic failure.

### Interior

Indoor wall applications require an overlap of 1/4 to 1/2 inch (6 to 13 mm).

### (1) Vertical Film Overlaps

Any overlaps on films applied vertically must face away from the front of the vehicle. Apply the first piece of film at the rear of the vehicle. Work to the front, overlapping each additional piece by 1/4 to 1/2 inch (6 to 13 mm), but no more than that. Repeat for the other side, again starting from the back.

### (2) Horizontal Film Overlaps

Apply the lower piece of film first. Work toward the top, overlapping each subsequent piece by 1/4 to 1/2 inch (6 to 13 mm), but no more than that.

## F. Registering the Graphic

Mark on the substrate the exact location of the top and sides of the graphic with masking tape, a lead pencil, or marking pen. Do not use a chalk line, china marker or grease pencil, which will contaminate the adhesive and cause edge failure.

## G. Removing the Adhesive's Liner

The procedure for removing the liner, whether just a small part of it or the entire liner, is to pull the liner away from the graphic at a 180 degree angle with a smooth continuous motion. See FIGURE 1.

Always remove the liner from the graphic rather than the graphic from the liner. This method helps ensure that the tape removes any prespaced graphics from the liner and it minimizes stretching or wrinkling of the graphic.

1. Lay the graphic liner side up against a flat, clean surface.
2. Flick a corner of the film with your finger or bend the corner to separate the liner from the adhesive. If the liner is scored, bend at the score.
3. Remove only as much liner as required for your application method. As you're removing the liner, keep your fingers away from the edge of the adhesive as much as possible. Contamination on the adhesive edges may cause the edges of the film to lift after application. See FIGURE 1.

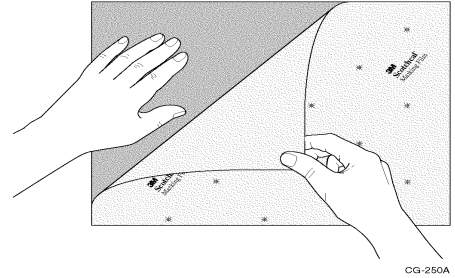

**FIGURE 1**  
Pulling Off a Liner

## H. Using Heat During Application

Heat is required during some application steps. Most films withstand a moderate amount of heat. However, films designated as polyolefin are more sensitive and can dull or curl if too much heat is used.



**CAUTION**

Heat or open flames may contribute to a flash fire or burns. Follow these precautions when using a heat source for flame treating.

- Read and follow the instructions supplied with the heat source.
- Avoid personal contact with the heat source. Wear heat-resistant gloves and safety glasses.
- Do not use heat sources near solvent mixtures or residues, or where solvent vapors may be present.



**CAUTION**

Always provide adequate ventilation to remove emissions that result from the heat of flame treating. Failure to provide adequate ventilation can result in operator exposure.

When handling any chemical products, read the manufacturers' container labels and the Safety Data Sheets (SDS) for important health, safety and environmental information. To obtain SDS sheets for 3M products go to [3M.com/MSDS](http://3M.com/MSDS), or by mail or in case of an emergency, call 1-800-364-3577 or 1-651-737-6501.

When using any equipment, always follow the manufacturers' instructions for safe operation.

## 9. APPLICATION SEQUENCES

### A. Applying a Small Graphic

A graphic is considered small if:

- It has positionable, pressure-activated adhesive and is less than 9 square feet (0.8 m<sup>2</sup>).
  - It has pressure-sensitive adhesive and is less than 4 square feet (0.4 m<sup>2</sup>).
1. Remove the entire liner.
  2. Use your thumb to gently tack the top edge of the graphic in place. See FIGURE 2.

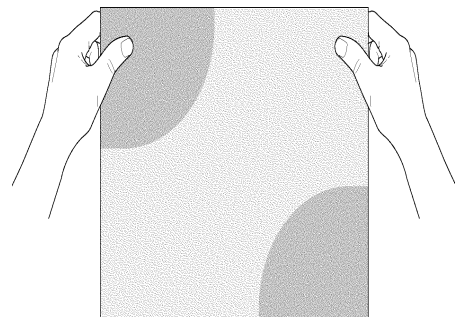

**FIGURE 2**  
Tack One Edge of Graphic

- Use firm pressure on the plastic applicator and overlapping strokes. If possible, start in the center of the graphic. Always squeegee the shortest distance to the edge of the graphic. Hold the remaining film away from the surface. See FIGURE 3.

Note: Pull the squeegee, as shown in FIGURE 3, rather than pushing it. Pushing can stretch the graphic.

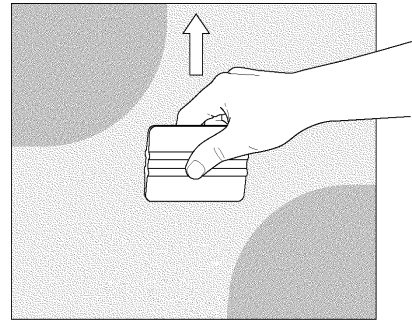

CG-253A

**FIGURE 3**

**Squeegee Across the Shortest Distance**

- Pull the film away from the substrate where you originally tacked it with your thumb and then squeegee that area; this prevents wrinkles. See FIGURE 4.

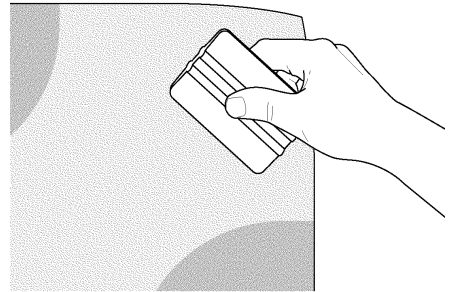

CG-254A

**FIGURE 4**

**Squeegee Area that was Previously Lightly Tacked**

- To complete the application, go to Finishing, on page 11.

## B. Applying a Large Graphic

A graphic is considered large if it has:

- Positionable, pressure-activated adhesive and is larger than 9 square feet (0.8 m<sup>2</sup>).
- Pressure-sensitive adhesive and is larger than 4 square feet (0.4 m<sup>2</sup>).

### (1) Top Hinge Method

- Position the graphic, using strips of Scotch™ Masking Tape to hold the graphic to the substrate. Then, apply a strip of masking tape 2 to 3 inch (5.1 to 7.5 cm) wide, horizontally across the top of the graphic. See FIGURE 5.

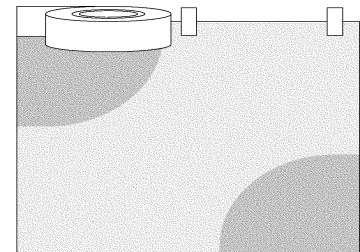

CG-255A

**FIGURE 5**

**Make a Top Hinge**

- Raise the graphic up over the top of the hinge and peel the liner back a few inches. See FIGURE 6.

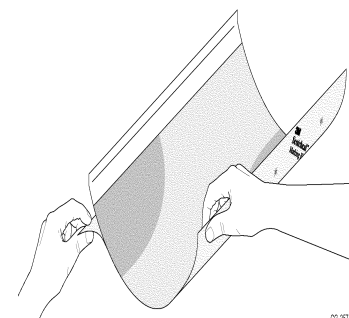

CG-256A

**FIGURE 6**

**Lift Graphic and Peel Back Liner**



Note: The entire liner may be removed at this time, if desired. However, for very large graphics, especially those with a pressure-sensitive adhesive, leaving the liner in place just prior to squeegeeing makes the graphic more controllable, keeps the adhesive clean, and reduces the possibility of stretching the film.

- Using care not to stretch the graphic, hold the graphic near bottom center and begin squeegeeing at the top center. Squeegee the graphic beginning at the center of the tape hinge and working outward from the hinge to the closest edge. Use firm pressure on the plastic applicator and overlapping strokes. See FIGURE 7.

Note: Pull the squeegee, as shown in FIGURE 7 rather than pushing it. Pushing can stretch the graphic.

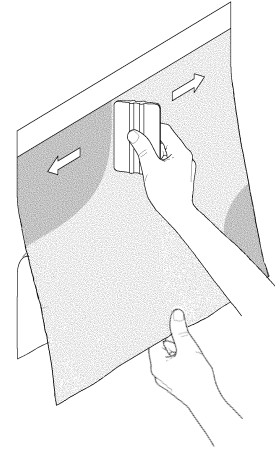

**FIGURE 7**  
**Squeegee a Top Hinged Graphic**

- Keep the graphic away from the surface and use two hands to peel back the liner a few more inches. See FIGURE 8. Then, continue squeegeeing the graphic using the technique described above.
- Continue to gradually remove the liner and squeegee until the entire graphic is applied.
- Remove the tape hinge. Squeegee the top edge.
- To complete the application, go to Finishing, on page 11.

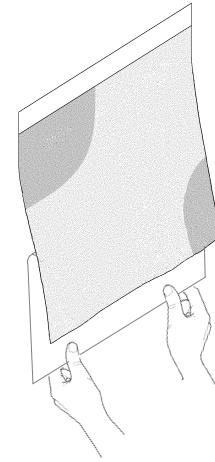

**FIGURE 8**  
**Use Two Hands to Remove Liner**

## (2) Center Hinge Method

- A center hinge can be either vertical or horizontal, whichever is the shortest distance.
- Position the graphic and hold it in place with 1 or 2 inch (2.5 to 5 cm) wide strips of masking tape.
- Apply two layers of masking tape, 1 or 2 inch (2.5 to 5 cm) wide, through the center of the graphic to make a hinge. The hinge should be perpendicular (at right angles) to the longest distance. See FIGURE 9.

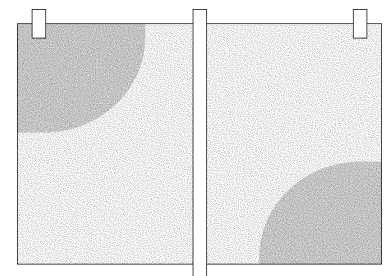

CG-259A

**FIGURE 9**  
**Make a Center Hinge**



4. Fold half of the graphic back over the hinge. Peel off the liner all the way to the tape hinge. Then cut just the liner along the hinge. Discard the liner. See FIGURE 10.
5. Fold the graphic back onto the substrate.
6. Gently hold the graphic away from the surface with one hand using care not to wrinkle or skew the graphic. Allow the adhesive to touch the substrate as pressure is applied during squeegeeing. Squeegee the graphic beginning at the center of the tape hinge and working outward to the closest edge. See Figure 11. Use firm pressure on the plastic applicator and overlap the strokes.
7. Remove the tape.
8. Apply the other half of the graphic in the same manner.
9. To complete the application, go to Finishing, on page 11.

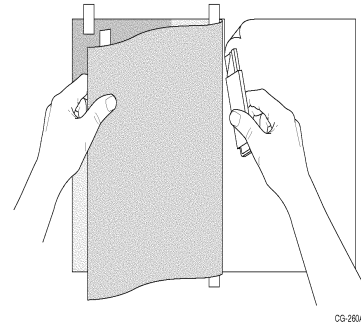

**FIGURE 10**  
Remove Liner at a Center Hinged Graphic

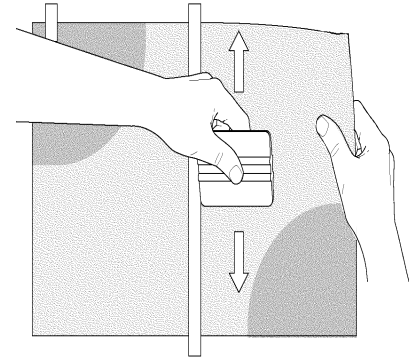
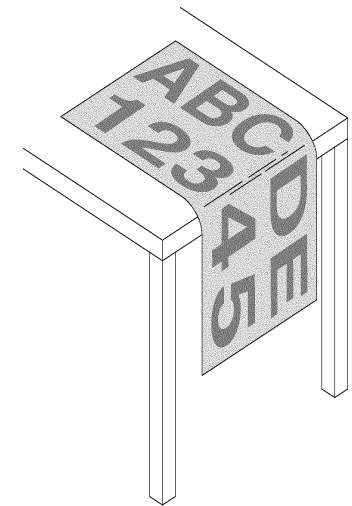

**FIGURE 11**  
Squeegee a Center Hinged Graphic

### C. Applying Large, Prespaced Graphics

Prespaced graphics have cut areas with large amounts of the liner exposed. Prespaced graphics should have an application tape already applied.

Note: If the application tape does not remove all of the prespaced graphics easily from the liner, press the elements back onto the liner. Then gently pull the graphic liner-side down over the corner edge of a surface. See FIGURE 12.



**FIGURE 12**  
Loosening Prespaced Graphics from Liner

1. Apply a hinge. See Top Hinge Method on page 7 and FIGURE 13.

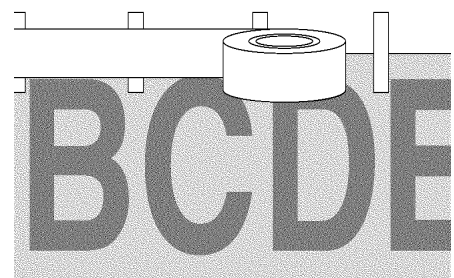

**FIGURE 13**  
Make a Top Hinge on Prespaced Graphics

2. Cut between each element, starting just above the top edge of the film, which is partially covered by tape. This makes an independent hinge for each element. See FIGURE 14. To avoid cutting the substrate, lift the graphic away from the substrate and cut only the film.
3. Remove the liner and squeegee each element in place. Use firm pressure and overlapping strokes. Always squeegee the shortest distance to the edge of each individual element.

Note: Squeegee over all areas of the prespaced graphics and application tape, not just the individual elements.

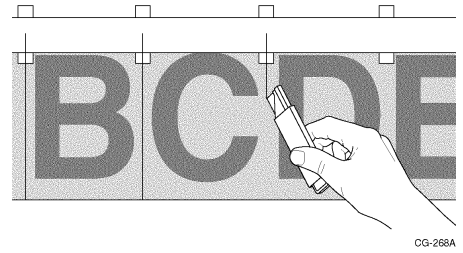
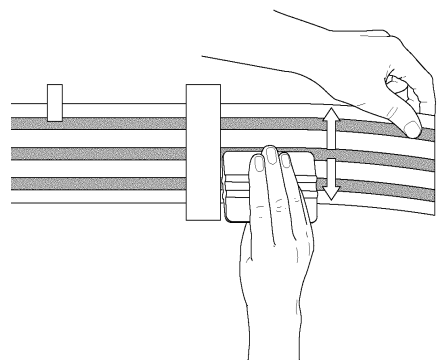

**FIGURE 14**  
Cut Between Elements of Prespaced Graphic

## D. Applying Striping

The preferred method for striping is to apply it so that it ends just before the edge of the substrate. An alternate method is to wrap the striping around the edge, such as on a door. However, this method subjects the film or sheeting to more abrasion. Both methods are described here.

1. Use the Center Hinge Method, page 8. Make the hinge perpendicular to the long dimension of the stripe. See FIGURE 15.



**FIGURE 15**  
Making Center Hinge for Striping

2. If the film/sheeting *will not* be wrapped around an edge, apply the stripe to within 1/4 inch (6 mm) of the substrate edge. See FIGURE 16.

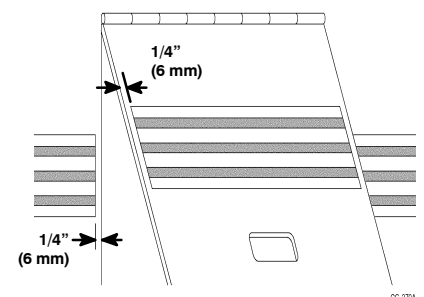

**FIGURE 16**  
Apply Striping without Wrapping

3. If the film *will be* wrapped around an edge:
  - a. Make sure the inside surface is clean.
  - b. Extend striping 1 inch (2.5 cm) or more beyond the edge.
  - c. Wrap firmly and squeegee the film to the back of the substrate. Avoid trapping air in this area. See FIGURE 17.

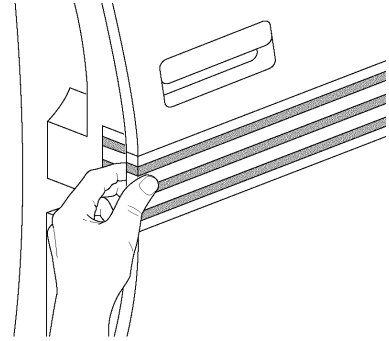

CG-271A

**FIGURE 17**  
Applying Striping With a Wrap

## E. Alternate Squeegee Technique

### (1) 3M™ Power Grip Applicator CPA-1

Applicator CPA-1 is for use ONLY with

- 3M graphic films with Comply adhesive.
- Flat surfaces with or without rivets (no corrugations or highly contoured surfaces).

1. Grip the tool as shown. See FIGURE 18.
2. Work from the center of the graphic outward.
3. Apply even pressure.
4. Use overlapping strokes to adhere the film to the substrate.

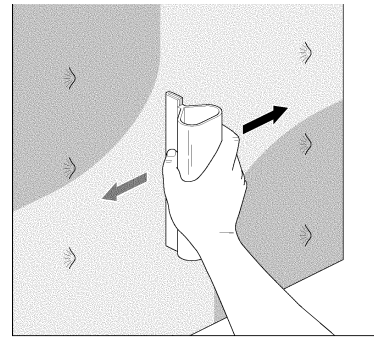

CG-240A

**FIGURE 18**  
Alternate Squeegee Technique

## 10. Finishing

### A. Removing the Application Tape

Note: Use a low friction sleeve on the squeegee if the graphic does not have an application tape or if the tape has been removed.

Note: Before removing the application tape, read about Rivets, later in this section.

Application tape should not be left on the graphic. Prolonged exposure to sunlight will permanently adhere it to the graphic.

Remove the application tape from the graphic by pulling it back upon itself at a 180 degree angle. See FIGURE 19. It is acceptable to tear the premask into manageable sized pieces.

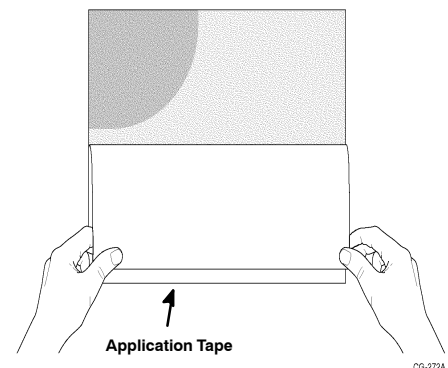

CG-272A

**FIGURE 19**  
Removing Application Tape

## B. Re-squeegeeing

### ***Important Note!***

ALWAYS re-squeegee after removing application tape, because removal may loosen the edges of the graphic. Re-squeegeeing is a critical step for all graphics, but especially if the film is thick or has pressure-activated adhesive, or if the substrate surface has any texture. Loose edges may lift and can be damaged if this step is skipped.

1. Use firm pressure to re-squeegee all rivets, graphic edges, substrate seams and film overlaps.
2. Give special consideration to graphics applied near the minimum application temperature.

Graphics may not develop ultimate adhesion if they are applied near the minimum application temperature and then put immediately into service in winter weather. To improve adhesion, which reduces edge lifting, use a heat gun along the rivets, film edges, substrate seams and overlaps when re-squeegeeing.

## C. Removing Air Bubbles

1. Inspect the graphic for bubbles.
2. Puncture the bubble at one end with a pin or the 3M™ Air Release Tool 391X. Do NOT use a razor blade or knife.
3. Press out the entrapped air by moving your thumb toward the puncture. See Figure 20.

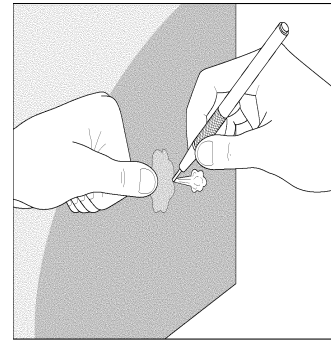

CG-273A

**FIGURE 20**  
**Puncture and Rub Out a Bubble**

## D. Air Release and Cutting Around Rivets and Bolts

### (1) Air Release Tool for Rivets

Applying film over raised areas such as rivets or bolts causes low to moderate tenting over the area, which traps air that must be removed.

1. Before removing the application tape, use a pin or the air release tool 391X to puncture several holes in the graphic. Or, use a multi-pin rivet air release tool MPP-1, which requires only one stroke to puncture several holes. Do NOT use a knife or razor blade. See FIGURE 21.

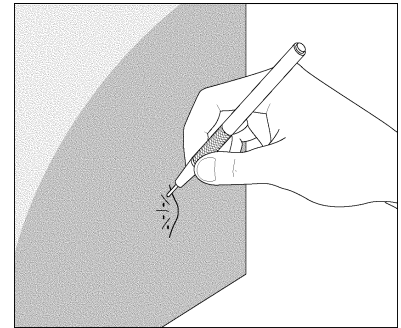

CG-274A

**FIGURE 21**  
**Puncturing Air Release Holes Around Rivets**

2. Push as much entrapped air as possible toward the punctures using a rivet brush or plastic applicator.
3. Remove the application tape at a 180 degree angle. Refer to FIGURE 19 on page 11.
4. Heat the film with a heat source held several inches away from the graphic and re-brush around the rivet. See FIGURE 22.

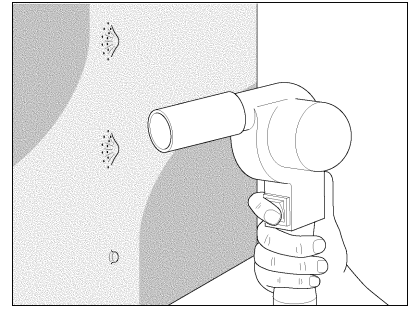

CG-275A

**FIGURE 22**  
**Heating Film Around Rivets**

Note: Overheating the film scorches it. Excessive heat softens the film too much and causes it to wrinkle. Heat softens the film so it will conform. Without sufficient heat, a 2 mil vinyl film will tent within time. All 4 mil films will eventually tent.

**(2) How to Use a Rivet Brush**

1. Start a circular brushing motion around the outer edges of the air release holes. See FIGURE 23, A.
2. Continue brushing as you narrow the circle to the area immediately over the rivet. This conforms the film to the rivet. See FIGURE 23, B.

**A. Start brushing in a larger circle**

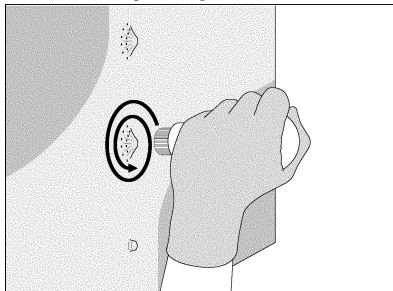

CG-276A

**B. Finish brushing in a small circle**

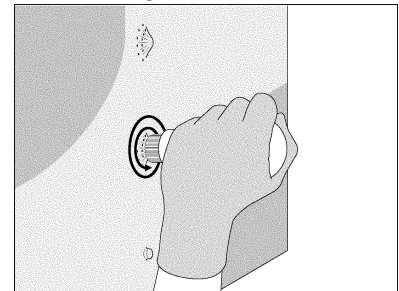

CG-286A

**FIGURE 23**  
**Conforming Film Around Rivets with A Brush**

**(3) 3M™ Power Grip Multi-Pin Rivet Air Release Tool MPP-1 for Comply films**

Air release tool MPP-1 makes multiple holes around a rivet with one strike. To use, remove and retain the black cover of the tool. Grip the tool as shown. Strike the area around the rivet once. DO NOT twist the tool. See FIGURE 24.

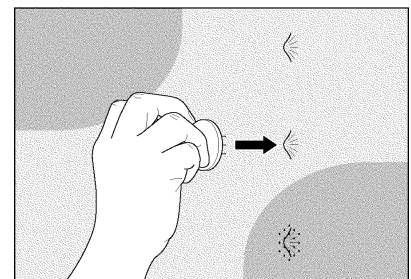

CG-234A

**FIGURE 24**  
**Using Multi-Pin Rivet Air Release Tool MPP-1**



**(4) 3M™ Power Grip Magic Pad Rivet Applicator CMP-1 for films with Comply Adhesive**

The CMP-1 can be used to conform hot vinyl film around small contoured shapes, such as rivets.

1. Puncture the film around the rivet using Air release tool MPP-1 or 391X.
2. Heat one rivet with a heat gun. See FIGURE 25. Use more heat that if you were using a rivet brush, but do not burn the film.
3. When the vinyl is hot and limp, firmly press the pad directly over the rivet and hold for 1 or 2 seconds to mold the film around the rivet. DO NOT twist the tool. See FIGURE 26.

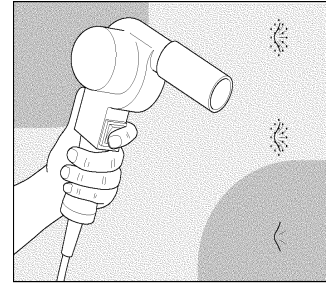

CG-265A

**FIGURE 25**  
**Heating a Rivet**

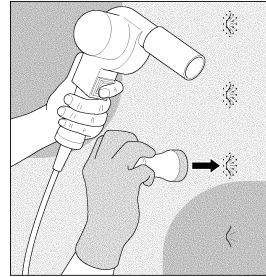

CG-238A

**FIGURE 26**  
**Molding Hot Film with Magic Pad Rivet Applicator CMP-1**

**(5) Cutting Around Rivets**

Some films and substrates require that the rivets be cut around. If the graphic is not cut, some lifting occurs and the graphic may crack and come loose later.

1. Use a film cutting tool around rivets under the following circumstances. See FIGURE 27.
  - Stainless steel substrates.
  - Film does not extend 0.5 inch (1.3 cm) or more beyond the rivet edge.
  - Rivets that are excessively high.
  - Reverse rivets, where the rivet head is on the inside and the film goes over the exposed shank end.
  - 3M™ Scotchlite™ Diamond Grade™ Sheeting.
  - If the base film (not including an overlamine) is greater than 2 mil (0.05 mm) thick and it is *not* a Scotchlite sheeting (except diamond grade sheeting), and:
    - the appearance of tented film over the rivets is objectionable, and/or
    - long-term, outdoor applications, and/or
    - applications where closely spaced rivets are closer than:
      - Single row 1.5 inches (3.8 cm)
      - Double row 3 inches (7.7 cm)
2. Remove the circles of film from the tops of the rivets, if desired.
3. Brush the film down in a circular motion with the rivet brush. See FIGURE 23, page 13.

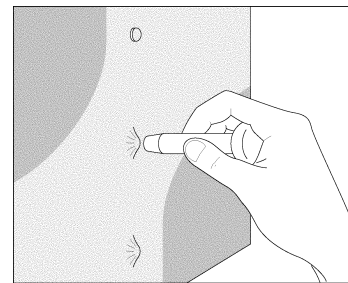

CG-277A

**FIGURE 27**  
**Cutting Around Rivets**



## (6) Cutting Around Bolts

1. Apply the graphic over the bolt just like you would over a rivet.
2. Cut an **X** through the film directly over the bolt. See FIGURE 28.
3. Brush the film down with the rivet brush held at a 45 degree angle.
4. Carefully cut the film around the bolt at a 90 degree angle or with a film cutting tool.

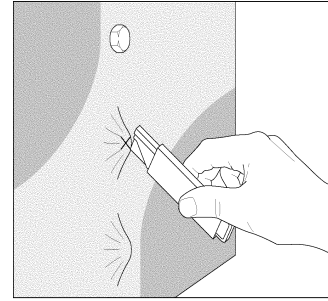

**FIGURE 28**  
Cutting Around Bolts

## E. Slitting Substrate at Seams

Seams in the substrate, whether or not they are caulked or filled, can retain moisture. They are also the point at which the substrate will flex under certain conditions. To ensure the film does not lift or tear at the seams, the graphic **MUST** be slit at the seam.

### (1) All Substrate Seams

Slit the graphic along the entire length of all substrate seams. Use a sharp razor blade in a safety holder. See FIGURE 29.

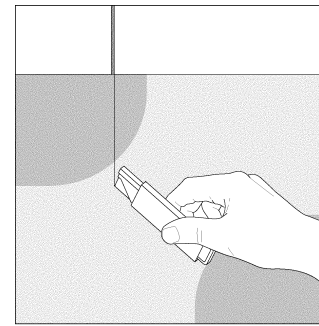

**FIGURE 29**  
Cutting Overlapped Substrate Seam

### (2) Seams with Caulking or Gaskets

1. Films that bridge over a caulked seam or gasket will not adhere. If the edges are not cut, moisture can get behind the graphic and cause it to fail. Cut the film on both sides of the caulking and remove the strip of film covering the caulking or gasket. See FIGURE 30.
2. Re-squeegee all seam edges with a plastic applicator or rivet brush.

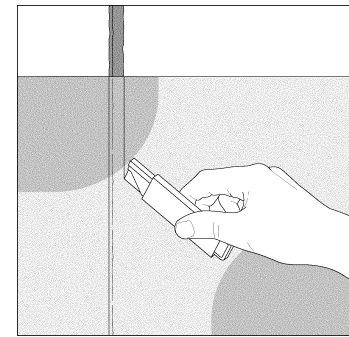

**FIGURE 30**  
Cutting at Caulked or Gasketed Substrate Seam

## 11. Edge Sealing



**CAUTION**

Before handling any chemical products, always read the container label and the SDS.

The following applications do not require edge sealing, but it may help keep the edges from lifting when subjected to external sources such as abrasion and/or high-pressure washing.

- Railroad rolling stock and locomotives
- Exposure to high-pressure wash
- Exposure to severe abrasion
- Chrome
- Truck roll-up doors

Note: If you use high pressure to wash a graphic, even if the edges are sealed, the warranty may be voided if you exceed the pressure washing recommendations in [3M Instruction Bulletin 6.5](#).

### A. Edge Sealing for Sheetings

Edge sealing is required when sheeting is used in fuel spill areas.

### B. Types of Edge Sealer

When in doubt, check the film's Product Bulletin for the appropriate edge sealer. These are general guidelines. Also refer to [3M Product Bulletin Edge Sealers](#).

Type of 3M Film	3M™ Edge Sealer	Minimum Temperature
Vinyl film	3950	50°F (10°C)
Polyolefin film	None	50°F (10°C)
Polyester film	Overprint clear 900	50°F (10°C)
Reflective sheeting	4433	55°F (13°C)
Diamond grade sheeting	Toner 880	50°F (10°C)

### C. How to Apply Edge Sealer

1. Do not apply edge sealer unless the temperature is above the minimum recommended temperature.
2. Remove the application tape and re-squeegee the edges before applying the edge sealer.
3. Use the felt dauber supplied with edge sealer or a 1/4 inch (0.6 cm) brush.
4. Wipe any excess edge sealer off the dauber or brush.
5. Hold the brush or the flat edge of the dauber so that it straddles the film and substrate
6. Pull the dauber or brush along the edge in a smooth, continuous motion. Make sure the entire edge is covered with no gaps. See FIGURE 31.

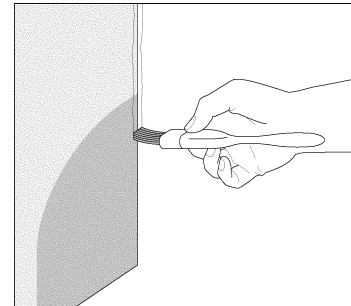

**FIGURE 31**  
Applying Edge Sealer

### D. Storing Edge Sealer 4433

- Edge sealer 4433 is a two-part system. It must be used immediately after mixing.
- Tightly seal the cap of the edge sealer container.
- Store in a cool, dry place.
- Use within 1 year of date of manufacture.

## 12. Irregular Surfaces and Shapes

### A. Rough, Textured and Irregular Surfaces

Use a rivet brush to conform the film to these surfaces.

Most interior wall surfaces are textured to some degree; please refer to [3M Instruction Bulletin 5.37, A Guide to Understanding and Applying Graphics to Common Interior Wall Surfaces](#), for proper testing and application recommendations.

### B. Complex, Compound Contours

Refer to [3M Instruction Bulletin 5.4, Special Applications and Vehicles](#).

### C. Posts and Inside Corners

1. Use the desired hinge method as described earlier in this bulletin. Make the hinge parallel to the post.
2. For exterior applications only, all film applied to inside (concave) corners must be cut. See FIGURE 32.
3. After cutting and removing the application tape, re-squeegee or use a rivet brush to make sure that film is securely applied.

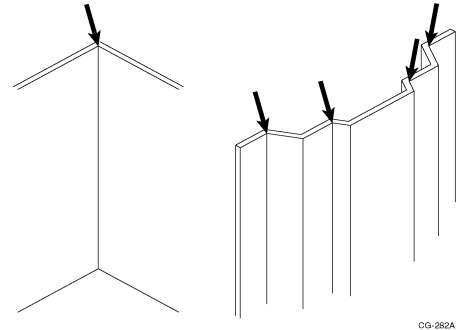

**FIGURE 32**  
Posts and Inside Corners

## 13. Warranty and Limited Remedy

The information contained and techniques described herein are believed to be reliable, but 3M makes no warranties, express or implied, including but not limited to any implied warranty of merchantability or fitness for a particular purpose.

### A. Limitation of Liability

Except where prohibited by law, 3M SHALL NOT UNDER ANY CIRCUMSTANCES BE LIABLE TO PURCHASER OR USER FOR ANY DIRECT, INDIRECT, SPECIAL, INCIDENTAL, OR CONSEQUENTIAL DAMAGES (INCLUDING, BUT NOT LIMITED TO, LABOR, NON-3M MATERIAL CHARGES, LOSS OF PROFITS, REVENUE, BUSINESS, OPPORTUNITY, OR GOODWILL) RESULTING FROM OR IN ANY WAY RELATED TO SELLER'S PRODUCTS OR SERVICES. This limitation of liability applies regardless of the legal or equitable theory under which such losses or damages are sought including breach of contract, breach of warranty, negligence, strict liability, or any other legal or equitable theory.

### B. Additional Warranty Information

The [3M Graphics Warranties Brochure](#) at 3Mgraphics.com, along with the applicable film Product Bulletins, provide the details to any warranty offered for the 3M graphics products described in this bulletin.

## 14. Bulletin Change Summary

Updated section 8.E. regarding panel overlap requirements and considerations for both interior and exterior graphics.



### Commercial Solutions

3M Center, Building 220-12E-04  
St. Paul, MN 55144 USA  
General & Technical  
1-800-328-3908  
Fax 1-651-736-4233

[www.3Mgraphics.com](http://www.3Mgraphics.com)

### 3M Canada

PO Box 5757  
London, Ontario  
Canada N6A 4T1  
General 1-800-265-1840  
Fax 519-452-6245

### 3M México S.A. de C.V.

Av. Santa Fe No. 55  
Col. Santa Fe, Del. Alvaro Obregón  
México D.F. 01210  
General 5255-5270-0400  
Fax 5255-5270-2277

### 3M Puerto Rico, Inc.

350 Chardon Avenue  
Suite 1100  
San Juan, PR 00918  
General 787-620-3000  
Fax 787-620-3018

3M, Controltac, Comply, Diamond Grade, Scotch, Scotchcal and Scotchlite are trademarks of 3M Company. All other trademarks are the property of their rightful owners.

©3M 2014. All rights reserved.